

PURETECH

PVR250x50-Ø20

EAN 4031582428339

Wheel centre made of Polypropylene, Tread: solid rubber, black, roller bearing



BETTER MOBILITY. BETTER LIFE.



Picture may differ from original product

Technical Data

Wheel diameter	250 mm
Wheel width	50 mm
Axle Hole-Ø	20 mm
Hub length	58 mm
Temperature	- 20 / + 60 °C
Standard	EN 12532
Weight	2.872 kg
Hardness of tread	Shore A 85
Load capacity	250 kg
Load capacity (static)	410 kg

Dimensions

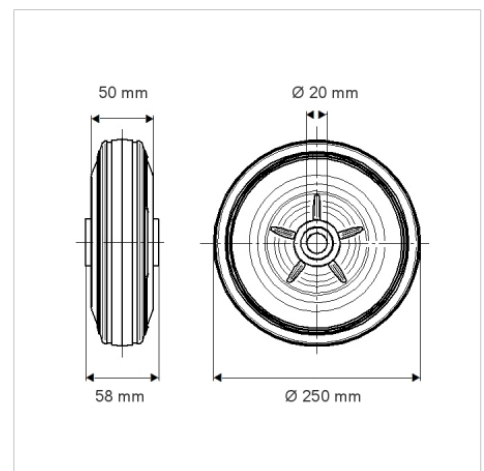

Advantages at a glance

Roll performance	● ● ● ○ ○
Movement noise	● ● ● ○ ○
Attrition	● ● ○ ○ ○
Corrosion resistance	● ● ● ○ ○