

# NOVATECH

## ITP160x50-Ø20 flat

EAN 4031582070323

Wheel centre made of Aluminium, Tread: Polyurethane, casted, precision ball bearing



BETTER MOBILITY. BETTER LIFE.



Picture may differ from original product

### Technical Data

Wheel diameter	160 mm
Width of Tread	50 mm
Axle Hole-Ø	20 mm
Hub length	60 mm
Temperature	- 20 / + 60 °C
Standard	EN 12532
Weight	1.07 kg
Hardness of tread	Shore D 42
Load capacity	800 kg
Load capacity (static)	1600 kg

### Dimensions

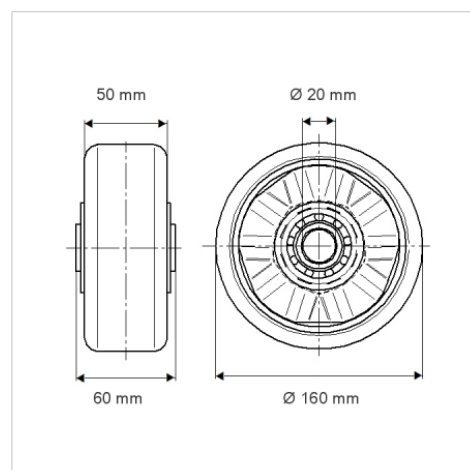

### Advantages at a glance

Roll performance	● ● ● ○ ○
Movement noise	● ● ● ○ ○
Attrition	● ● ● ● ○
Corrosion resistance	● ● ● ○ ○

### Structure & Mounting

