

COMPACTA

2198UOI030P60-45X20

EAN 4031582030068

Fixed castor, Fork made of pressed steel, bright zinc plated, blue passivated, axle riveted, plate fitting.

Wheel centre made of Polyamide, plain bearing



BETTER MOBILITY. BETTER LIFE.



Picture may differ from original product

Technical Data

Wheel diameter	30 mm
Width of Tread	15 mm
Castor width	20 mm
Size of Plate	45 x 20 mm
Plate hole centres	35 mm
Plate hole	5,5 mm
Dome-Ø	20 mm
Overall height	34 mm
Temperature	- 25 / - 25 °C
Standard	EN 12528
Weight	0.031 kg
Hardness of tread	Shore D 75
Load capacity	30 kg
Load capacity (static)	60 kg

Dimensions

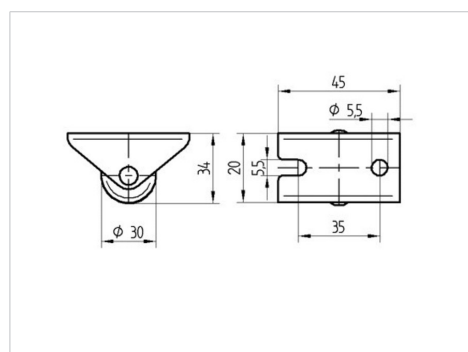

Advantages at a glance

Roll performance	● ● ● ○ ○
Movement noise	● ● ● ○ ○
Attrition	● ● ● ● ●
Corrosion resistance	● ● ● ○ ○